



# Downloading the software

From the Darfon Solar website download the file “H5000/H5001 Application Software”. You can follow the link below.

- [http://www.darfonsolar.com/downloads/?product\\_id=14&download\\_type\\_id=8](http://www.darfonsolar.com/downloads/?product_id=14&download_type_id=8)

**DARFON** Discover ▾ Products ▾ How to Buy ▾ Warranty Resources ▾ Contact ▾ Company ▾ Monitoring Portal

Home / Resources / Downloads

## Downloads

General Downloads  
This section contains white papers, application notes and case studies.

Document	Type	File Size	Download
How to use H5000 as Emergency Power in Puerto Rico	App Notes	2.36 MB	
Inverter Comparison for G320	White Paper	0.51 MB	
Advantages of IP T-Cables	White Paper	0.12 MB	
Surge Supression For MIC300	White Paper	0.17 MB	

Product Specific Downloads  
This section contains product brochures, manuals, warranties and certification documents.

Filter By: H5000 Hybrid Inverter ▾ Software ▾

Document	File Size	Download
H5000/H5001 Application Software	0.42 MB	

## ◆ Adding the Software to your Computer

- Create a working directory for the software
- Unzip the download file in your working directory and you are done.
- Your folder contents should look like the one below.

Name	Date modified	Type	Size
en-US	6/21/2018 11:51 AM	File folder	
zh-TW	6/21/2018 11:51 AM	File folder	
CaliDefault	10/17/2017 3:37 PM	Text Document	1 KB
Darfon HyBrid AP Tool	6/21/2018 12:09 PM	Application	517 KB
Darfon HyBrid AP Tool.pdb	6/21/2018 12:09 PM	PDB File	420 KB
DebugLog	6/21/2018 12:09 PM	Text Document	0 KB
ModbusDefinition	6/18/2015 2:31 PM	Text Document	2 KB
Parameter	7/16/2015 3:48 PM	Text Document	1 KB
README	6/11/2018 11:25 AM	Text Document	1 KB
Setting	6/21/2018 12:09 PM	Configuration sett...	1 KB

## ◆ Talking to the Inverter

- You will need a USB-A to USB-B cable on hand before you start.
- Remove the access cover that is held in place by 2 philips screws

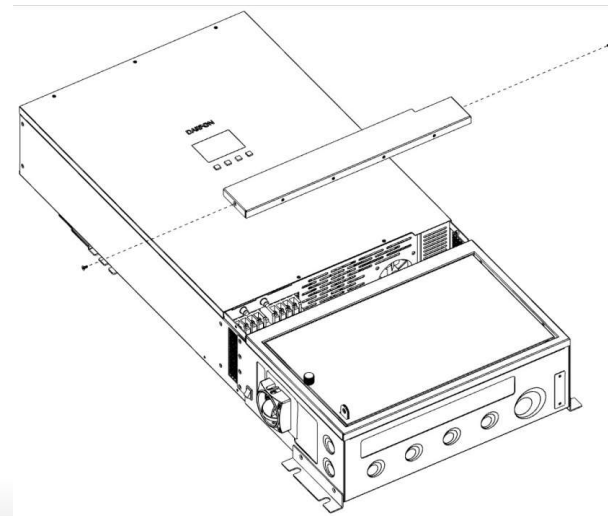

## ◊ Talking to the Inverter (cont.)

- Connect the USB cable to the inverter as shown below.
- Connect the other end of the cable to a USB port on your laptop.





## Talking to the Inverter (cont.)

Launch the Darfon Hybrid AP Tool

Name	Date modified	Type	Size
en-US	6/21/2018 11:51 AM	File folder	
zh-TW	6/21/2018 11:51 AM	File folder	
CaliDefault	10/17/2017 3:37 PM	Text Document	1 KB
Darfon Hybrid AP Tool	6/21/2018 12:09 PM	Application	517 KB
Darfon Hybrid AP Tool.pdb	6/21/2018 12:09 PM	PDB File	420 KB
DebugLog	6/21/2018 12:09 PM	Text Document	0 KB
ModbusDefinition	6/18/2015 2:31 PM	Text Document	2 KB
Parameter	7/16/2015 3:48 PM	Text Document	1 KB
README	6/11/2018 11:25 AM	Text Document	1 KB
Setting	6/21/2018 12:09 PM	Configuration sett...	1 KB

## ◊ Talking to the Inverter (cont.)

A user level login requires no password.

You can see a nice amount of what is happening with your inverter very easily. Nothing can be changed from this login level.

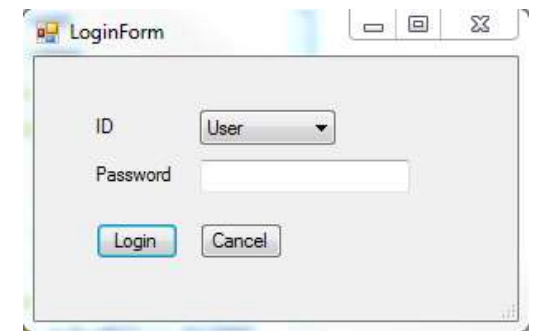

## Talking to the Inverter (cont.)

You must set the Serial COM Port. The Baudrate is 9600 and the computer will assign the COM port. In this case, my computer allocated COM15. Click on OK.

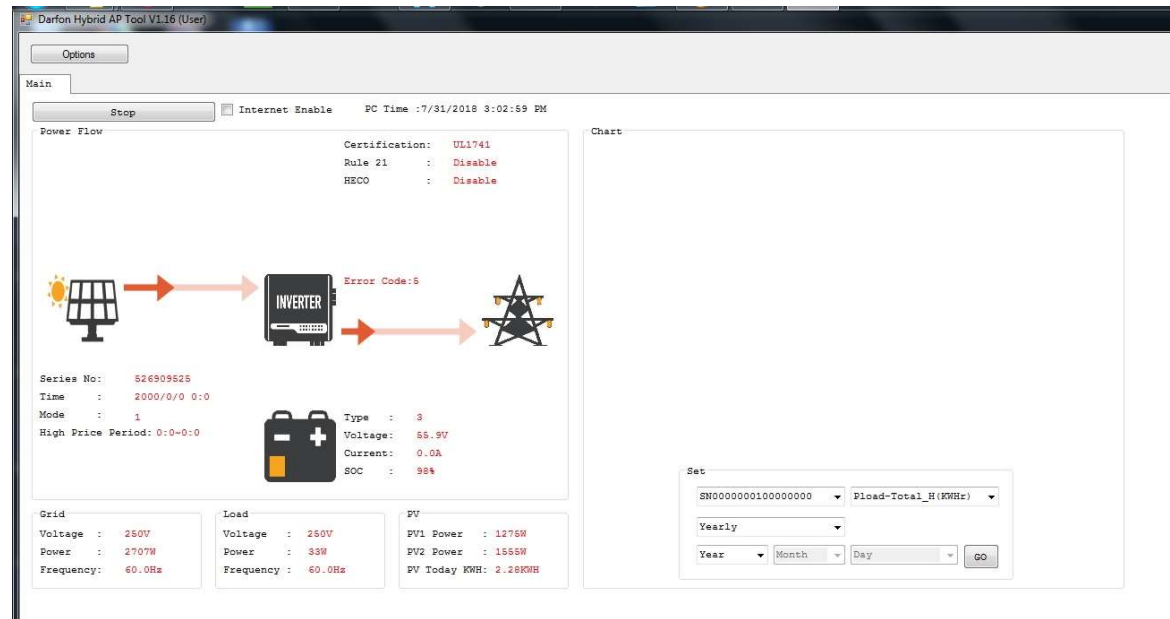

This is the default screen for the User login.

## ◆ Talking to the Inverter (cont.)

- An installer level login requires the password “Installer1234”. The password is case sensitive. Also, please note that we do NOT publish this password in the manual.
- You will also need to set the COM port for this login as you did with the User login.



- From this login you can make substantial changes to the way the H5000 works.

Caution: You can make the system perform better or a lot worse depending on what you do here.



# Talking to the Inverter (cont.)

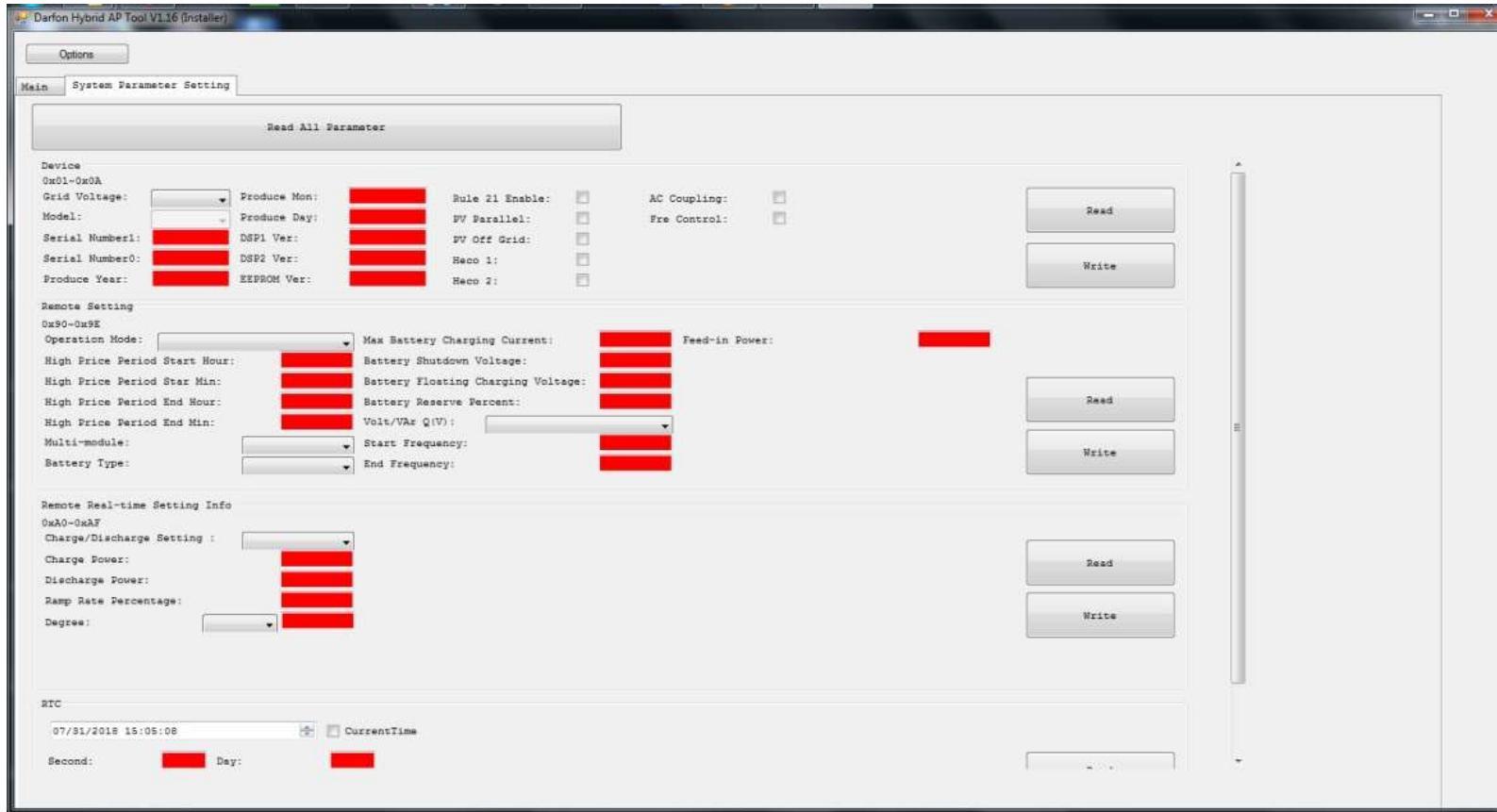

## Talking to the Inverter (cont.)

Clicking on “Read All Parameters” will collect the current register contents from the inverter.

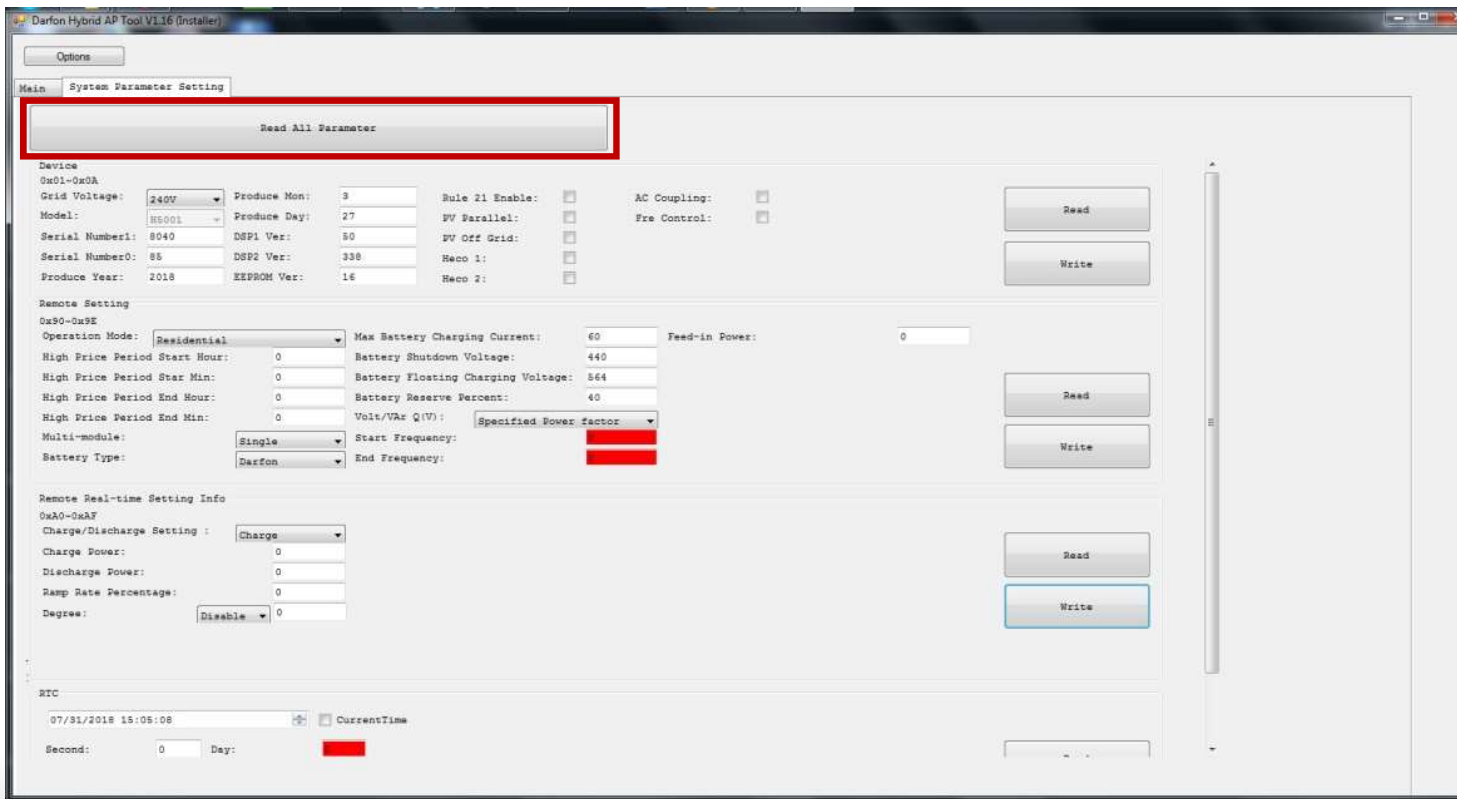

## Talking to the Inverter (cont.)

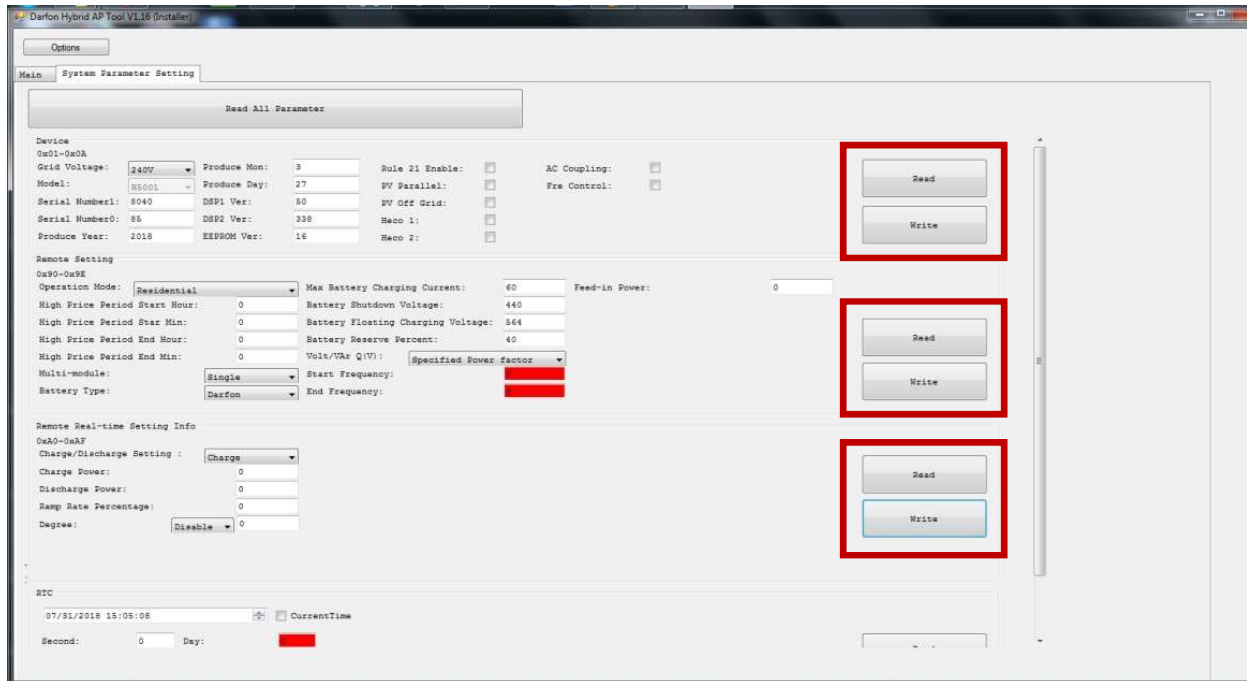

Read and write registers by sections to reduce the potential of changing a register you didn't mean to.

- Press “Read” to get the current values from the inverter.
- Make your changes.
- Then Press “Write” to implement the changes.
- Turn off the inverter with the rocker switch. Wait for 15 seconds before turning the system back on.
- Press “Read” to confirm the new values are set in the EEPROM.

## Talking to the Inverter (cont.)

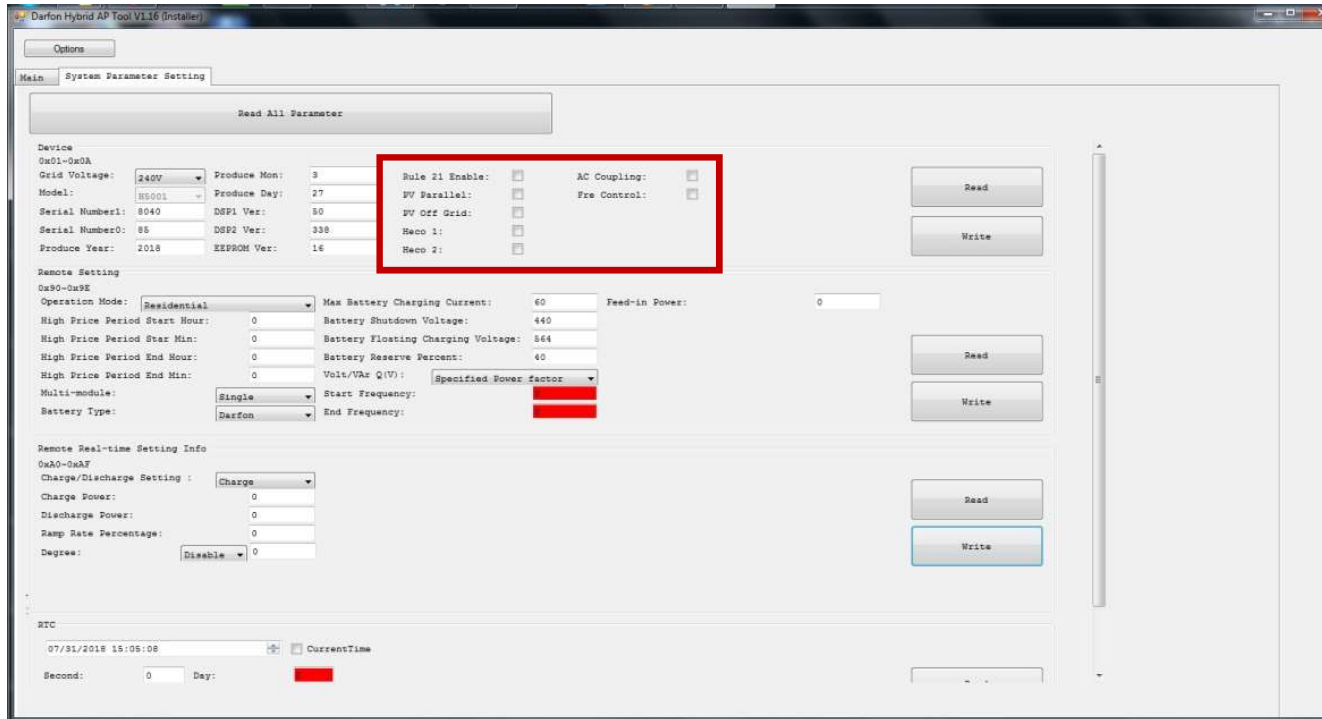

There are check boxes that activate specific features.

- The 2 most commonly used are PV Off Grid and Rule 21.
- Check “PV Off Grid”, if your system is a true off grid installation. Several changes are made to power flow and how deeply the battery is discharged.
- Check “Rule 21 Enable”, if you are in California or any state that requires Rule 21 compliancy.

## Talking to the Inverter(cont.)

Options

Main System Parameter Setting

Read All Parameter

Device

0x01-0x0A

Grid Voltage: 240V Produce Mon: 3 **Rule 21 Enable:**  AC Coupling:  Read

Model: H5001 Produce Day: 27 Fre Control:  Write

Serial Number1: 8040 DSP1 Ver: 30 PV Off Grid:

Serial Number0: 85 DSP2 Ver: 338 Heco 1:

Produce Year: 2018 EEPROM Ver: 16 Heco 2:

Remote Setting

0x90-0x9E

Operation Mode: Residential Max Battery Charging Current: 60 Feed-in Power: 0

High Price Period Start Hour: 0 Battery Shutdown Voltage: 440

High Price Period Start Min: 0 Battery Floating Charging Voltage: 564

High Price Period End Hour: 0 Battery Reserve Percent: 40

High Price Period End Min: 0 Volt/Var Q(V): Specified Power factor

Multi-module: Single Start Frequency:  Read

Battery Type: Darfon End Frequency:  Write

Remote Real-time Setting Info

0x40-0x4F

Charge/Discharge Setting: Charge

Charge Power: 0

Discharge Power: 0

Ramp Rate Percentage: 0

Degree: Disable

RTC

07/31/2018 15:05:08  CurrentTime

Second: 0 Day:

- For Rule 21, you will need to know what the local utility values are.
- Check “Rule 21 Enable”
- Set the Volt/Var, Start Frequency and End Frequency values.
- Press “Write”, then restart the inverter.

# Integrate Fortress Battery to H5001/H5000

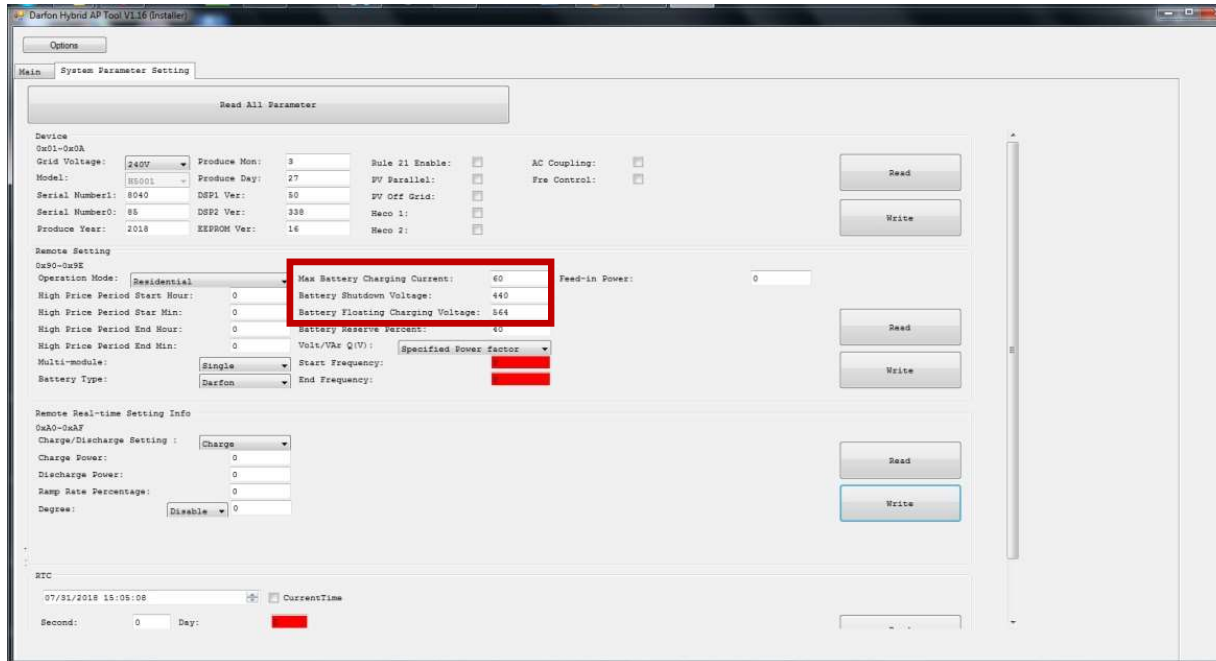

- A) Select Battery type: Lead Acid
- B) The most common fields that need to be adjusted are
- Max Battery Charging current: 60A
  - Battery Shutdown Voltage: 48V
  - Battery Floating Charging Voltage: 57.6V
  - Battery reserved percentage: 10%

Note: Voltage values are read as if there is a decimal point between the two rightmost digits. So 446 is 44.6V and 564 is 56.4V.